

Varenummer: 20343540M10KS
Beskrivelse: E+G Justerfod
GN 343.5-40-M10-KS

Mål

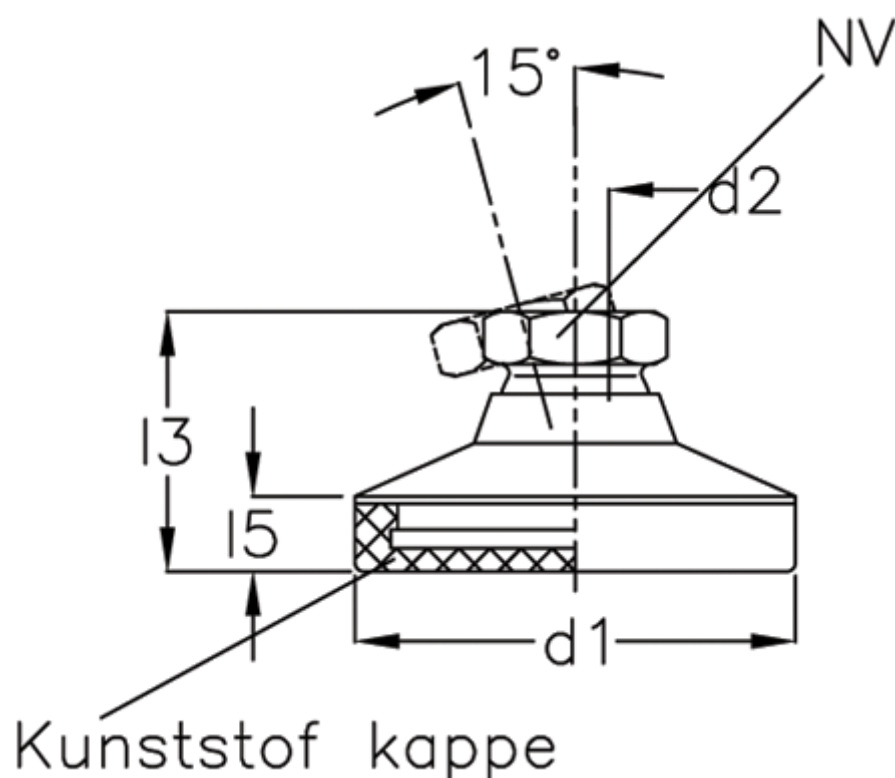

d1	= 40
d2	= 10
l3	= 27.5
l5	= 7.5
NV	= 15
Statisk belastning (N)	= 11
t min	= 10.5